

# ktech

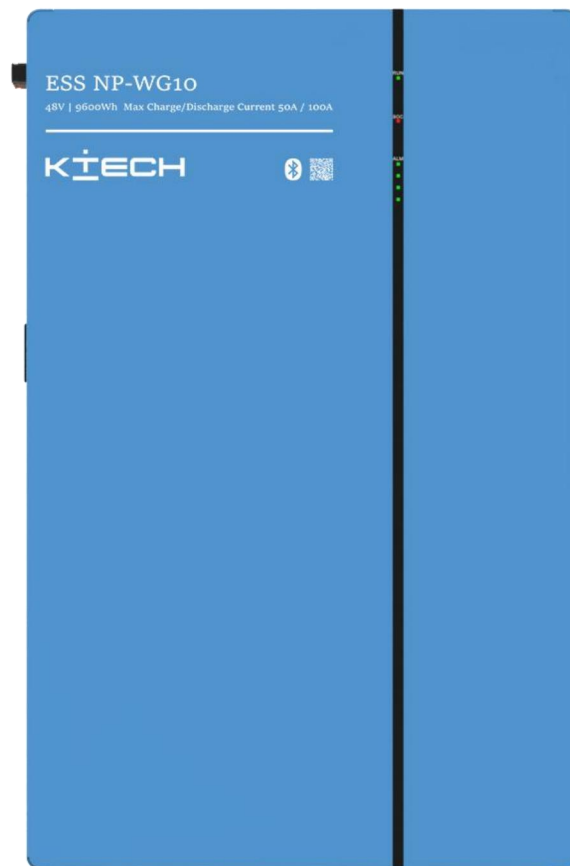

## User Manual

ESS NP-WG10

# NicePower Series

## **About Ktech Energy NicePower Series Batteries**

NicePower Series batteries can be installed in Parallel mode; more attention should be paid for the DIP and address selection following with part 5.3.

## **About This Manual**

This manual is intended for the NicePower Series battery, but the hybrid inverter and any other equipment is not included. The Ktech Energy hot line is available if you want to get additional information.

## **Declaration**

We declare that this NicePower Series is compliance with the essential requirements.

# Contents

<b>About Ktech Energy NicePower Series Batteries .....</b>	<b>II</b>
<b>About This Manual .....</b>	<b>II</b>
<b>Declaration .....</b>	<b>II</b>
<b>1. Instructions .....</b>	<b>- 5 -</b>
1.1 Range of Application .....	- 5 -
1.2 Meaning of Abbreviations .....	- 5 -
<b>2. Safety Precautions - 5 -</b>	
2.1 Important Safety Instructions .....	- 5 -
2.2 Safety Symbols .....	- 6 -
2.3 General Safety .....	- 6 -
2.3.1 Important Notice .....	- 6 -
2.3.2 General Requirements .....	- 7 -
2.3.3 Personnel Safety .....	- 7 -
2.4 Personnel Requirements .....	- 8 -
2.5 Battery Handling Guide .....	- 9 -
2.6 Electrical Safety .....	- 9 -
2.6.1 General Requirements .....	- 9 -
2.6.2 Grounding Requirements .....	- 10 -
2.7 Installation Environment Requirements .....	- 10 -
<b>3. System Installation .....</b>	<b>- 11 -</b>
3.1 Safety Instruments .....	- 11 -
3.2 Selection of Installation Location .....	- 11 -
3.3 Installation Requirements .....	- 11 -
3.4 Device Installation .....	- 12 -
3.4.1 Installation Location Selection .....	- 12 -
3.4.2 Install Expansion Bolts .....	- 12 -
3.4.3 Install Battery Pack .....	- 14 -
3.5 Battery Installation .....	- 14 -

3.5.1 Connecting Signal Line .....	- 14 -
3.6 Installation Process .....	- 16 -
<b>4. Electrical Connection .....</b>	<b>- 16 -</b>
4.1 Cable Materials .....	- 16 -
<b>5. Commissioning .....</b>	<b>- 17 -</b>
5.1 Debug Batteries .....	- 17 -
5.2 Shutting Down Battery .....	- 17 -
5.3 Battery Module Address Setting .....	- 17 -
<b>6. Response to Emergency Situations</b> .....	<b>- 19 -</b>
<b>7. Contact Information .....</b>	<b>- 20 -</b>

## 1. Instructions

Thank you so much for choosing the NicePower series energy storage system developed and produced by our company. Please read and understand all contents of the Manual carefully before installing and using the product. If you have any suggestions during the use, please do not hesitate to give us feedback.

### 1.1 Range of Application

The installation and user manual of NicePower series is applicable to the installation and use of the following products:

Model	Rated energy
NP WG10	9.6kWh

The product should be used in compliance with local standards, laws and regulations, because any noncompliance with the use may lead to personal injuries and property loss.

The drawings provided in this manual are used to explain the concepts related to the product, including product information, installation guide, electrical connection, system debugging, safety information, common problems and maintenance, etc.

The internal parameters of this product have been adjusted before delivery. No internal parameters can be changed without permission. Any unauthorized changes to the settings will invalidate the warranty, and the company will not be liable for any loss resulting therefrom.

This Manual and other related documents are an integral part of the product and should be kept properly for onsite installation personnel and related technical personnel to consult.

### 1.2 Meaning of Abbreviations

AC	Alternating Current
DC	Direct Current
PV	Photovoltaic
BMS	Battery Management System
PCS	Power Conversion System
RJ45	Registered Jack 45
SOC	State Of Charge
C	Charge C-rate
RS485	RS485 Communication Interface
CAN	Controller Area Network

## 2. Safety Precautions







### 2.1 Important Safety Instructions

This manual contains important instructions for: NicePower Series energy storage product and this manual must be followed when installing and using this product. The product is designed and tested in accordance

with international safety requirements IEC 60364, but as with all electrical and electronic equipment, certain precautions must be observed when installing and/or operating the product. To reduce the risk of personal injury and ensure the safe installation and operation of the product, you must carefully read and follow all instructions, cautions and warnings in this manual.

## 2.2 Safety Symbols

This product contains the following symbols, please pay attention to identifying.

Symbol	Description
	Caution, risk of electric shock
	Heavy enough may cause severe injuries
	Keep the battery away from open flame or ignition sources
	Keep the battery away from children
	Do not dispose of the product with household waste
	Recycling
	Read this manual before installation and operation

For safety reasons, installers are responsible for familiarizing themselves with the contents of this manual and all warnings before performing installation.

## 2.3 General Safety

### 2.3.1 Important Notice









The matters indicated with "DANGER", "CAUTION", "ATTENTION" and "NOTICE" in this Manual do not represent all the safety matters to be observed, but are only the supplements to all the safety precautions. The Company will not be liable for any violation of general safety operating requirements, or any violation of safety standards for the design, production and use of the device. The device must be used in an environment that meets the requirements of the design specifications. Otherwise, the device may fail, and the abnormal device function or component damage, personal safety accident, and property loss arising from this are not covered within the quality assurance scope of the device. When installing, operating, and maintaining the device, the local laws, regulations, and codes shall be followed. The safety precautions in this Manual are only supplements to local laws, regulations, and codes. The Company shall not be liable for any of the following circumstances.

- The device is not run under the conditions of operating described in this Manual.
- The installation and operating environment is beyond the requirements of relevant international or national standards.
- The product is disassembled or changed, or the software code is modified without

authorization.

- The operation instructions and safety warnings related with the product and in the documents are not followed.
- Damage of the device is caused by abnormal natural environment (force majeure, such as earthquake, fire, and storm).
- Transportation damage is caused during customer's own transportation.
- The storage condition does not meet the requirements of the product related documents and causes damage.

### 2.3.2 General Requirements

	<p>Operating when the power is on is strictly prohibited during installation.</p>
	<p>It is strictly prohibited to install, use, and operate any outdoor equipment or cables (including but not limited to transporting equipment, operating equipment and cables, plugging and removing signal ports connected to the outdoor, working at altitude, and outdoor installation) in severe weather, such as thunder, rain, snow, and gale level 6.</p>
	<p>In case of any fire, evacuate the building or equipment area and press the fire alarm bell or dial the fire call. Under any circumstances, re-entry into a burning building is strictly prohibited.</p>
	<p>Under no circumstances should the structure and installation sequence of the device be changed without the manufacturer's permission.</p>
	<p>The battery terminal components shall not be affected during transportation. And, the battery terminal bolts shall not be lifted or transported.</p>
	<p>It is strictly prohibited to alter, damage or block the marks and nameplates on the device.</p>
	<p>The composition and working principle of the entire photovoltaic power generation system, as well as the relevant standards of the country/region where the project is located shall be known fully.</p>
	<p>After the device is installed, the empty packing materials, such as cartons, foam, plastics, and cable ties, shall be removed from the device area.</p>

### 2.3.3 Personnel Safety

- When operating the device, appropriate personal protective equipment shall be

worn. If any fault that may lead to personal injury or damage of the device is found, immediately terminate the operation, report to the responsible person, and take effective protective measures.

- Before using any tools, learn the correct method of using the tool to avoid injuries and damage of the device.
- When the device is running, the temperature of the case is high, which may cause burns. Therefore, do not touch the case.
- In order to ensure personal safety and normal use, reliable grounding should be carried out before use.
- Do not open or damage the battery. The electrolyte released is harmful to skin and eyes, so avoid touch it.
- Do not place irrelevant items on the top of the device or insert them into any part of the device.
- Do not place flammable items around the device.
- Never place the battery in the fire to avoid explosion and prevent the personal safety from being endangered.
- Do not place the battery module in water or other liquids.
- Do not short-circuit the battery terminals, because short-circuiting of the battery may cause combustion.
- The battery may pose a risk of causing electric shocks and large short-circuit currents. When using the battery, the following precautions should be paid attention to:
  - a) The metal objects, such as watch and rings, shall be removed.
  - b) Tools with insulated handles should be used.
  - c) Rubber gloves and shoes should be worn.
  - d) The charging power supply shall be disconnected before connecting or disconnecting terminals of the battery.
  - e) Check whether the battery is accidentally grounded. If the battery is accidentally grounded, remove the power supply from the ground.
- Do not clean the internal and external electrical components of the cabinet with water or detergent.
- Do not stand, lean or sit on the device.
- Do not damage any modules of the device.

#### **2.4 Personnel Requirements**

- The personnel in charge of installation and maintenance must be strictly trained to understand all safety precautions and master proper operation methods.
- Only qualified professionals or trained personnel are allowed to install, operate and maintain the device.
- The personnel who operate the device, including the operators, trained personnel and professionals, must have special operation qualifications required by the local country, such as high voltage operation, working high above the ground, and special equipment operation qualification.
- The replacement of device or components (including software) must be carried



out by professionals or authorized personnel.

## 2.5 Battery Handling Guide

- Use the battery pack only as directed.
- If the battery is defective, appears cracked, broken or otherwise damaged, or fails to operate, contact the Ktech hot line immediately.
- Do not attempt to open, disassemble, repair, tamper with, or modify the battery. The battery pack is not user serviceable.
- To protect the battery and its components from damage when transporting, handle with care.
- Do not subject it to any strong force.
- Do not insert foreign objects into any part of the battery pack.
- Do not use cleaning solvents to clean the battery.
- Cartons that have been crushed, punctured, or torn in such a way that contents are revealed shall be set aside in an isolated area and inspected by a skilled person. If the package is deemed to be not shippable, the contents shall be promptly collected, segregated, and either the consignor or consignee contacted.

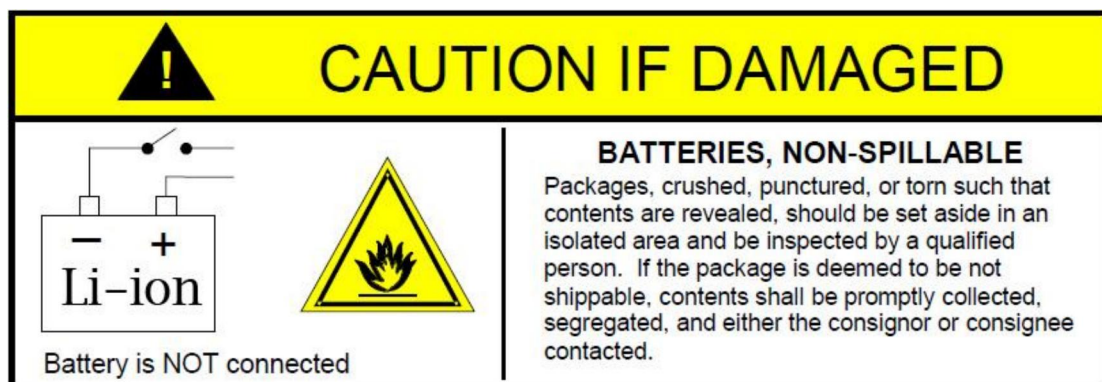

The DC circuit of Ktech battery NicePower Series has been disconnected before outgoing.

- A precautionary label had been affixed to the shipping carton to alert individuals as to the battery within the package have been disconnected; otherwise, the battery should not be transported.
- We have conducted comprehensive tests to ensure the equipment they distribute around the world is safe for shipping transport. These products shall be handled with care and immediately inspected if visibly damaged. If the cartoon visibly damaged, please contract with Ktech hot line to confirm whether the battery could be used safely or not.



## 2.6 Electrical Safety

### 2.6.1 General Requirements

	<p>Before carrying out electrical connections, ensure that the device is not damaged, or an electric shock or fire may occur.</p>
	<p>Never install or remove any power cables when the power is on. The electric arcs or sparks may be generated at the moment when the power cable contacts with the conductor, which may cause fire or personal injuries.</p>

- All the electrical connections must meet the electrical standards of the country/region where the project is located.
- The cables prepared by users themselves shall comply with local laws and regulations.
- Special insulating tools should be used in high-voltage operations.
- Before connecting the power cord, ensure that the label identification on the power cord is correct.
- Operations on the device are allowed only five minutes after the device is completely powered off.
- The insulation layer of the cable may be aged or damaged when the cable is used in a high temperature environment. Therefore, the distance between the cable and the heat source must be at least 30mm.
- Cables of the same type should be bundled together. Whereas, the cables of different types should be routed at least 30mm apart, and shall not be wrapped together or crossed.

#### 2.6.2 Grounding Requirements

- When installing the device to be grounded, the protective grounding wire must be installed first; when removing the device, the protective grounding wire must be removed at last.
- It is forbidden to destroy the grounding conductor.
- It is forbidden to operate the device without a grounding conductor installed.
- The device shall be permanently connected to the protective grounding wire. Before operating the device, electrical connection of the device shall be checked to ensure that the device is reliably grounded.

#### 2.7 Installation Environment Requirements

- This product is for indoor use only, and is strictly prohibited to be used in outdoor environment.
- Do not install or use this product in an environment where the temperature is lower than -10°C or higher than 50°C.
- It should be installed in a dry and well-ventilated environment to ensure good heat dissipation performance.
- The product can be installed at a maximum altitude of 2,000m.
- The installation position should be away from the fire source.
- The product should be installed and used away from children and animals.

- The installation position should be far away from water sources, such as faucets, sewer pipes, and sprinklers, to avoid entering of water.
- The device should be placed on a firm and flat supporting surface.
- Do not place any inflammable or explosive items around the device.
- When the device is running, do not block the ventilation vent or heat dissipation system to prevent fire caused by high temperature.

	<p>The operation and service life of the energy storage is related to the operating temperature. The energy storage should be installed at a temperature equal to or better than the ambient temperature.</p>
--	---



### 3. System Installation

#### 3.1 Safety Instruments

When dealing with the battery, following safety gears should be equipped. Installers must meet the relevant requirements of IEC 60364 or the domestic legislation and other relevant international standards.



Insulated glove

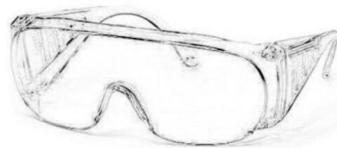

Safety goggles



Safety shoes

#### 3.2 Selection of Installation Location

Make sure that the installation location meets the following conditions:

- The building is designed to withstand earthquakes, and the floor is flat and level.
- Far away from the sea to avoid salt water and humidity.
- The installed location should not be access by pet and children.
- No flammable or explosive materials nearby, at least 2.5m far away from combustible.
- Minimal dust and dirt in the area.
- No corrosive gases present, including ammonia and acid vapor.
- The battery optimal operate temperature is 15°C to 30°C. Frequent exposure to severe operating condition would exacerbate the performance and lifetime of the battery.

#### 3.3 Installation Requirements

For safe use of battery, please notice following notes when install:

- The installation shall be in a restricted access location/ room or in a cabinet where

provides a barriers for the battery terminal.

- The maximum number of batteries shall be not over 8 PCS.
- DVC class specification: DVC-C for battery terminal, DVC-A2 for all communication terminals.



### 3.4 Device Installation

#### 3.4.1 Installation Location Selection

Ktech battery NicePower Series is suggested installing by skilled worker or electrician. A skilled worker is defined as a people who had been trained and qualified electrician or had all of the following skills and experience:

- Knowledge of the functional principles and operation of on-grid Energy Storage systems.
- Knowledge of the dangers and risks associated with installing and using electrical devices and acceptable mitigation methods.
- Knowledge of the installation of electrical devices
- Knowledge of and adherence to this manual and all safety precautions and best practices.

#### 3.4.2 Install Expansion Bolts

	<p>In order to avoid electrical shock or other injury, inspect existing electronic or plumbing installations before drilling holes.</p>
	<p>Choose suitable firm wall with thickness greater than 100mm.</p>

Step 1: Place the battery on the ground against the wall.

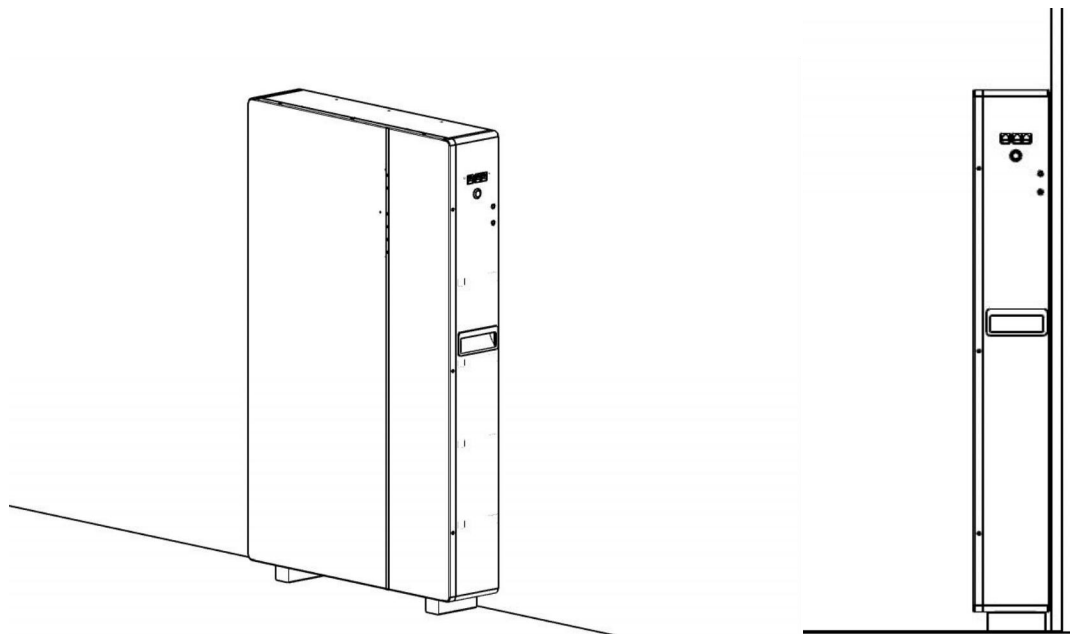

Step 2: Align the bent patch with the holes on both sides of the battery and lock it tightly with M6 screws.

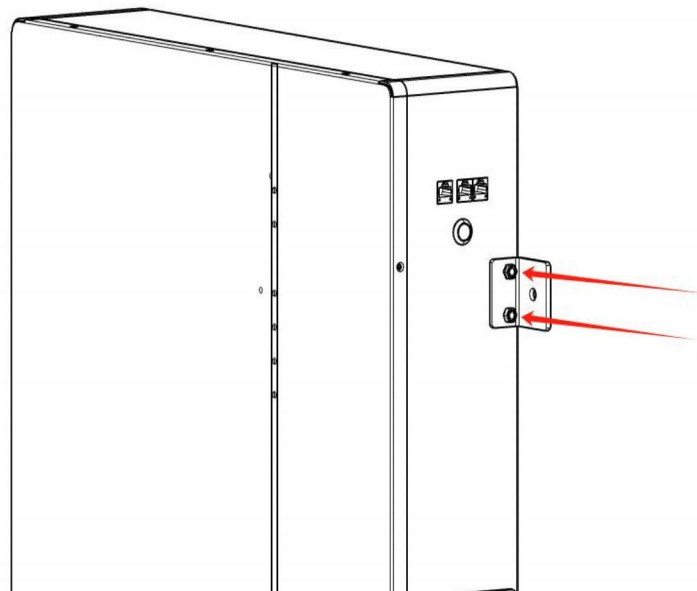
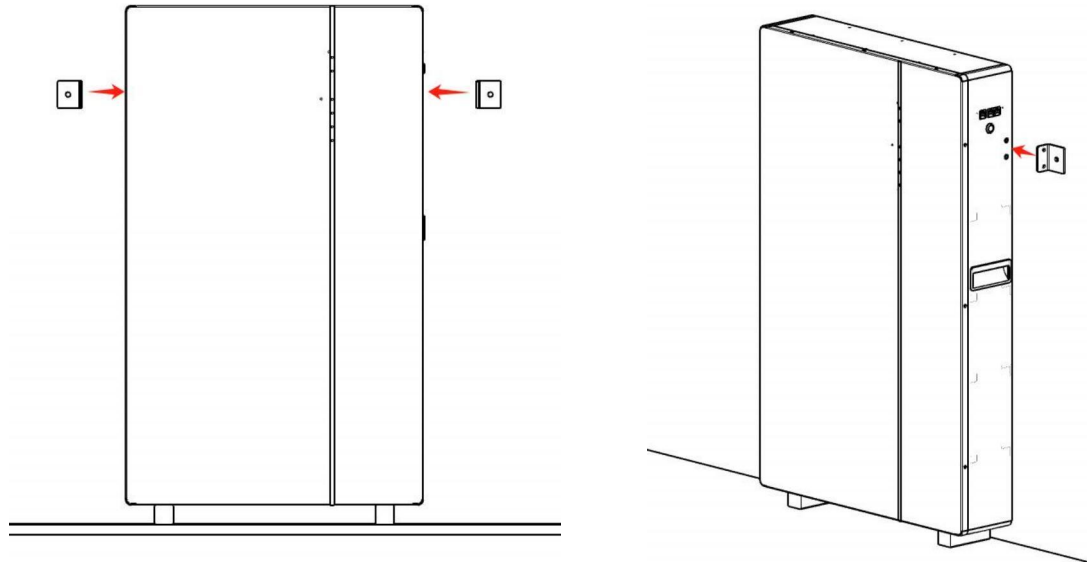

Step 3: Align the expansion screws of the M8 with the holes in the bending patch.

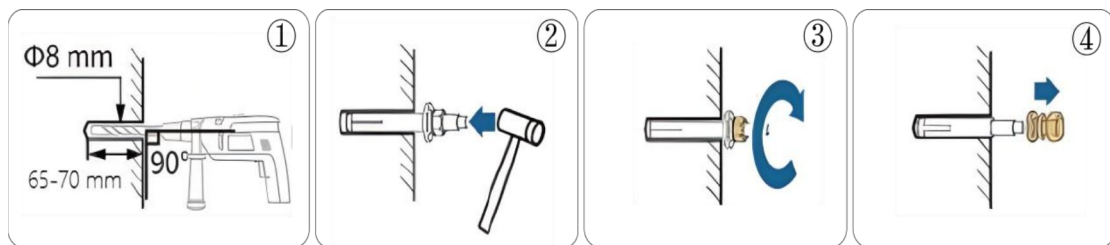
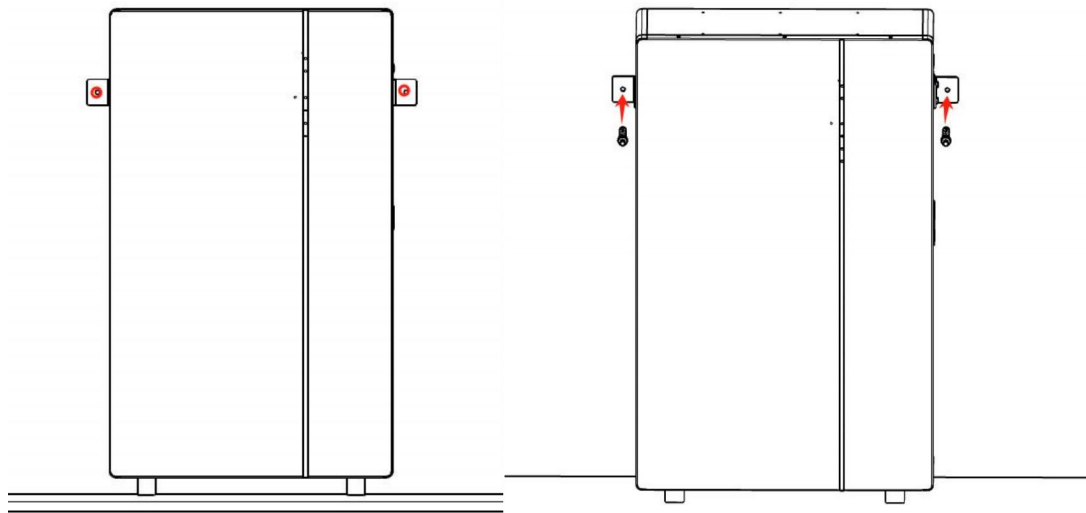

### 3.4.3 Install Battery Pack

	<p>Installing the battery pack requires several people due to its heavy weight.</p>
--	---

### NOTICE

If the battery is installed on a wall, make sure that the wall is capable of supporting the battery's weight.

## 3.5 Battery Installation

### 3.5.1 Connecting Signal Line

Connect the inverter after paralleling the batteries.

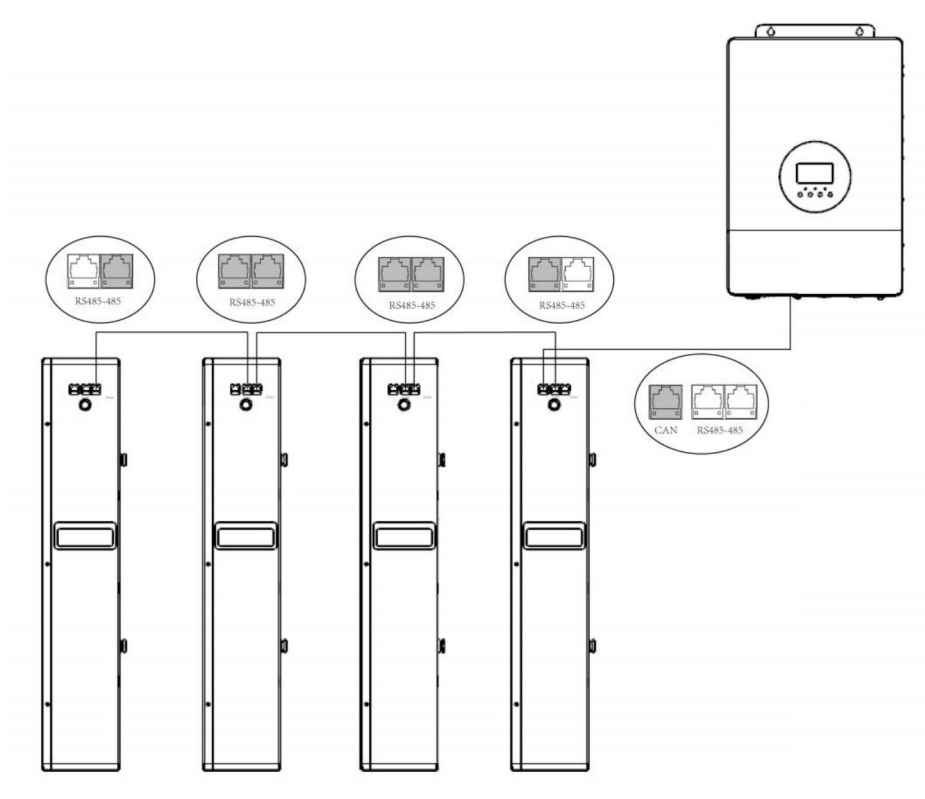
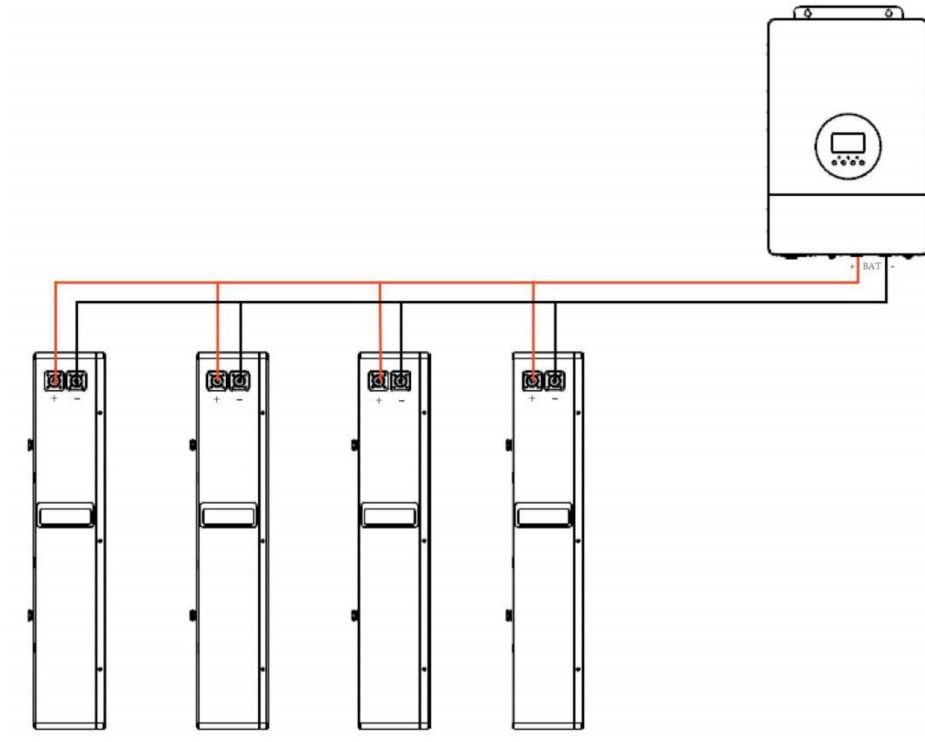



If there are multiple batteries, you need to connect the communication line of each battery. Battery and battery connection use RS485-485 interface, battery and inverter connection need RS485-CAN interface.

### 3.6 Installation Process

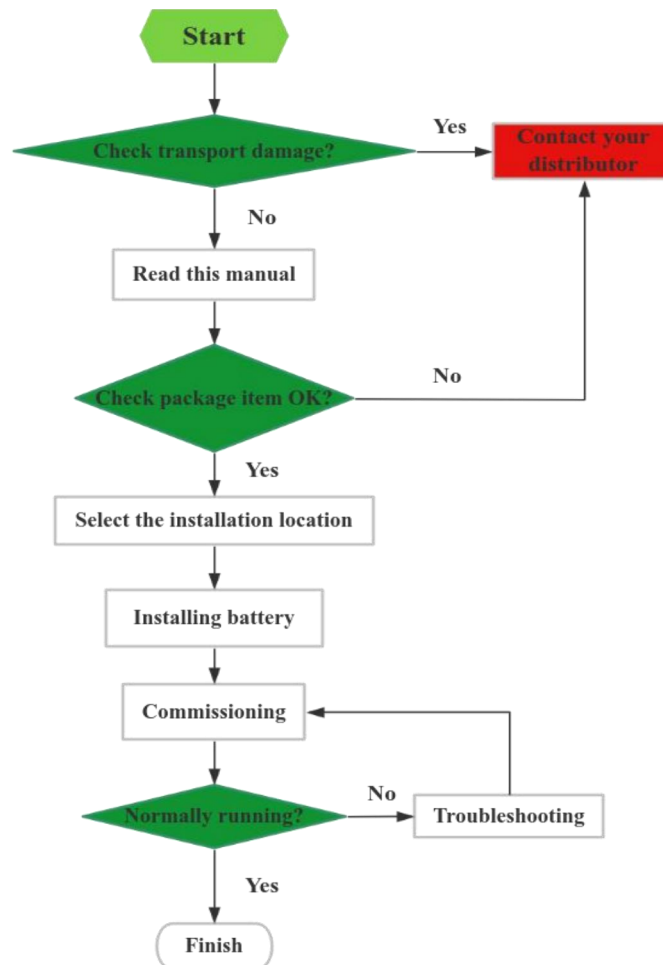
The battery should be installed according to the following flow chart.



## 4. Electrical Connection

	<p>Before electrical connection, please ensure that the switches of the energy storage are in the "OFF" state. Otherwise, the high voltage of the device may cause electric shock.</p>
	<p>The operations related to electrical connections must be carried out by professional electrical technicians. When carrying out electrical connections, the operator must wear personal protective articles.</p>

### 4.1 Cable Materials

The following installation materials should be prepared by installers.

- ① Copper nose SC25-8
- ② Orange EV wire
- ③ Black EV wire



- ④ Ethernet cable
- ⑤ Ethernet cable protective sleeve

When two or more battery systems in parallel, each of them shall have a bipolar isolator. Meanwhile, the isolator shall have ability to break the full load current.

#### NOTICE

Make sure that the cross-sectional area of charging cables is 25 to 35 mm<sup>2</sup>. A breaker between Ktech battery and inverter was recommended to install, and the breaker's min. current should be over 150A or following with local regulations.

## 5. Commissioning

### 5.1 Debug Batteries

If there is only one battery installed, use the following steps to put it in operation:

- Press the panel button, after the indicator lights on, release the panel button.
- Make sure that the Run light is on. If it stays off, do not use the battery and contact Ktech or your distributor.
- Turn the inverter on, and wait for the start-up sequence to complete fully.

When there are two or more batteries connected with parallel mode, after the charging cable and the data cable has been connected correctly, follow these steps to put them in operation:

- Check battery voltage level is above 48V
  - a) If battery voltage is under 45V contact your distributor or Ktech After-sale service hot line for help.
  - Release the panel button, after few seconds the indicator lights off.
  - Before commissioning the system, please pay attention on following tips:
    - a) For all of the batteries, make sure that the Run light is on.
    - b) Make sure the maximum voltage difference between batteries is less than 1.5V.
    - c) If not, the installer should balance the battery voltage before connecting the batteries in parallel.
    - d) Set the DIP switches like **5.3**.
  - Turn the inverter on, and wait for the start-up sequence to complete fully.

### 5.2 Shutting Down Battery

Shut down the battery only when the battery under standby status.

- Release the Panel Button, after few seconds the battery will turn off itself.
- Make sure that every light on the battery is off.

### 5.3 Battery Module Address Setting

If BMS is turned on the automatic dip switch function and connect the communication cable to the machine, the battery pack will be automatically addressed. To enable the automatic DIP switch function, perform the following steps:

- ① The communication line needs to be connected according to the automatic dialing

method, and the dialing switch does not need to be enabled. When multiple machines are connected in parallel, the dial switch is automatically used, the RS485 interface connection is as shown in the figure below

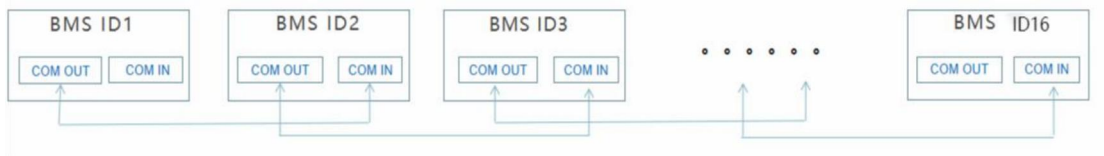

② The host computer opens the automatic dip function

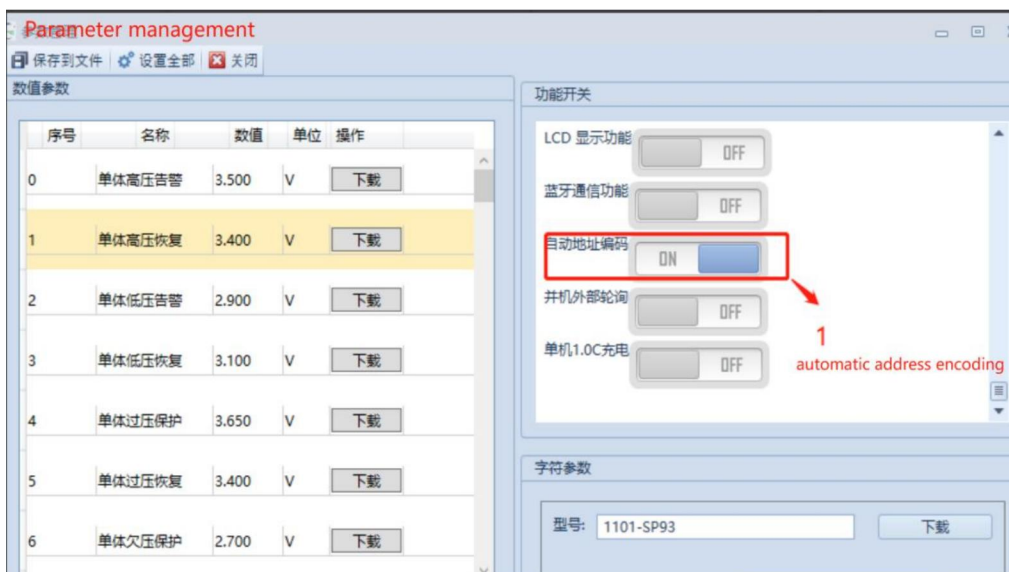

**NOTICE**

Before two or more batteries installed in parallel, please check the voltage of each battery and make sure the voltage difference is less than 2.0V.

## 6. Response to Emergency Situations

The Ktech battery NicePower Series is designed with multiple safety strategies to prevent hazards resulting from failures. However, Ktech cannot guarantee their absolute safety for uncertain situations.

### 6.1 Leaking Batteries

If the battery pack leaks electrolyte, avoid contact with the leaking liquid or gas. Electrolyte is corrosive and contact may cause skin irritation and chemical burns. If one is exposed to the leaked substance, do these actions:

**Inhalation:** Evacuate the contaminated area, and seek medical attention immediately.

**Eyes contact:** Rinse eyes with flowing water for 15 minutes, and seek medical attention immediately.

**Skin contact:** Wash the affected area thoroughly with soap and water, and seek medical attention immediately.

**Ingestion:** Induce vomiting as soon as possible, and seek medical attention immediately.

### 6.2 Fire

In case of a fire, make sure that an ABC or carbon dioxide extinguisher is nearby and does not use water to extinguish the fire.

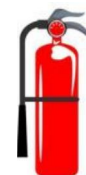

### WARNING

The battery pack may catch fire when heated above 130°C.

If a fire breaks out where the battery is installed, do these actions:

1. Extinguish the fire before the battery catches fire.
2. If the battery has caught fire, do not try to extinguish the fire. Evacuate people immediately.

If the battery catches fire, it will produce poisonous gases. Do not approach.

### 6.3 Wet Battery

If the battery is wet or submerged in water, do not try to access it. Contact Ktech hot line or your distributor for technical assistance.

### 6.4 Damaged Battery

If the battery is damaged, please contact Ktech hot line or your distributor for help as soon as possible, because a damaged battery is dangerous and must be handled with extreme caution. A damaged battery is not suitable for use and may pose a danger to people.

## CAUTION

Damaged battery might export electrolyte or flammable gas, so contact Ktech for advice and information immediately we will deal with it within 48h.

### 6.5 Scrap Battery

For scrap battery(-ies), please treat with local laws or regulations to recycle or scrap.

### 6.6 Storage

If the battery is not to be installed immediately, or removed from operation and needs to be stored for a long period, please choose an appropriate location to store it. Instructions for storage are:

- Do not stack more than 8 battery boxes.
- The temperature of battery stored recommended in the range of -20°C to 25°C.
- Do not expose to water.
- The battery box should be upright as shown in the following figure and not stacked upside down when storing the battery box.

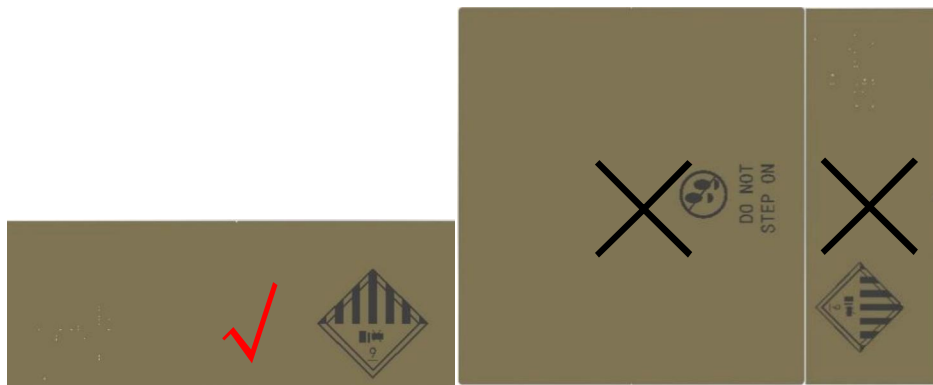

If the battery needs to be stored over 3 months, the DC circuit of battery suggests to be disconnecting. Otherwise, the battery would discharge at a minimum rate and capacity degrades depended on storage time, the battery self-consumption less than 5w. And, if the battery stored over 6 months, it is suggested to connect the battery with inverter and commission the system.

## 7. Contact Information

Use the contacts below for technical assistance. This phone numbers is available only during business hours on weekdays.

Address	No.8-1 Yanqiao Road, Yanqiao Industrial Park. Huishan District, Wuxi City, Jiangsu, China
E-mail	<a href="mailto:info@ktechsolar.com">info@ktechsolar.com</a>